

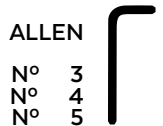

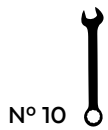



HONDA CB750 HORNET '23-

M O U N T I N G I N S T R U C T I O N S

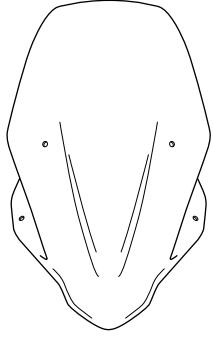
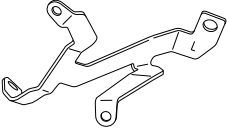
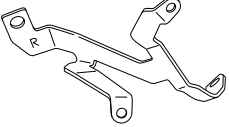
REF 21480

WINDSHIELD NG TOURING



ID	PIEZA/PART	DESCRIPCIÓN	DESCRIPTION	QTY	REF
1		Cúpula Touring	Touring screen	1	21480H/W/F/NM
2		Soporte Izquierdo (L)	Left support (L)	1	SOPOR2P5-L21479
3		Soporte derecho (R)	Right support (R)	1	SOPOR2P5-R21479
4		Tornillo M6x16 Ø14 ISO 7380	M6x16 Ø14 ISO 7380 Allen screw	2	TORNI-I7380-403
5		Silentblock Ø12xØ6x9	Ø12xØ6x9 Silentblock	4	AROPASACABLES-1
6		Casquillo con valona Ø12xØ6,8x7,3	Ø12xØ6,8x7,3 bush with flange	4	CASQUI-1A---750
7		Tornillo Allen M5x12 Ø11 ISO 7380	M5x12 Ø11 ISO 7380 Allen screw	4	TORNI-AI----520
8		Tapón tornillo M5 ISO 7380	M5 ISO 7380 screw cap	4	TAPON-----85

HONDA CB750 HORNET '23-

INSTRUCCIONES DE MONTAJE - MOUNTING INSTRUCTIONS - MONTAGEANLEITUNG

1

DISASSEMBLY
DESMONTAJE

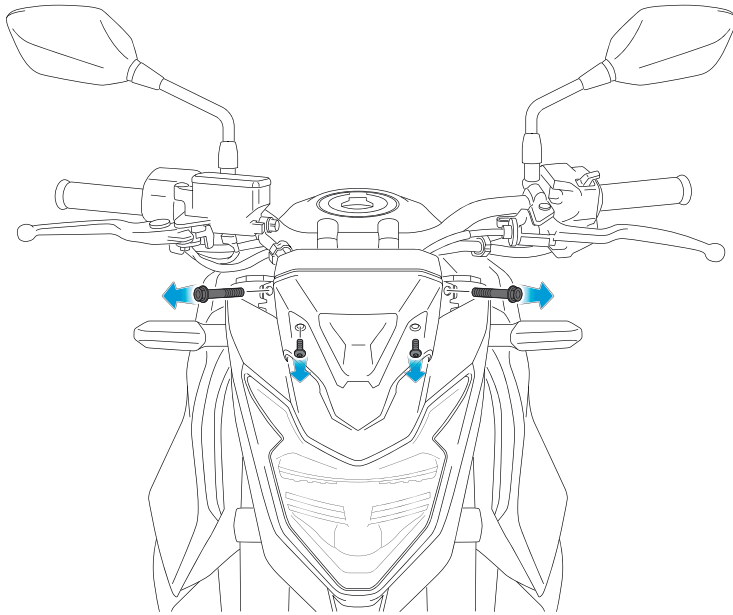

NO EXTRAER TODOS LOS TORNILLOS A LA VEZ.
REALIZAR EL MONTAJE DE LOS SOPORTES UNO POR UNO.

DO NOT REMOVE ALL THE SCREWS AT THE SAME TIME.
MOUNT THE SUPPORTS ONE BY ONE.

2

ASSEMBLY
MONTAJE

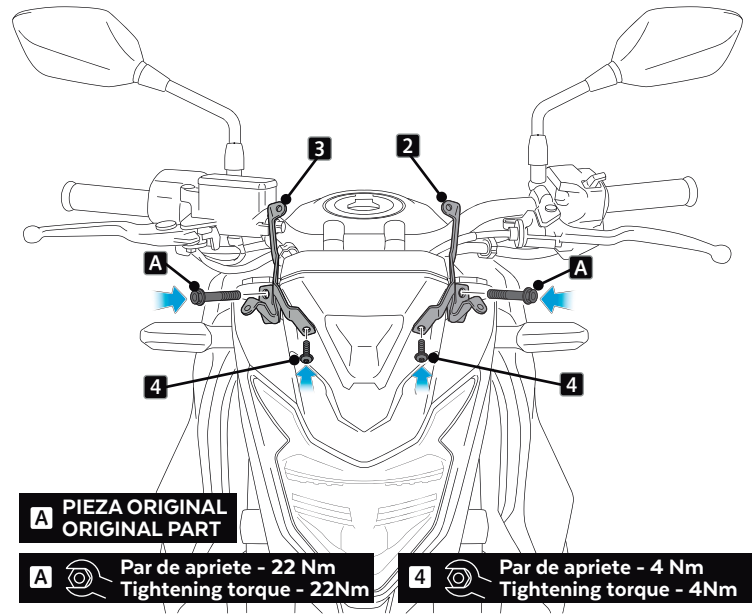

A PIEZA ORIGINAL
ORIGINAL PART

A Par de apriete - 22 Nm
Tightening torque - 22Nm

4 Par de apriete - 4 Nm
Tightening torque - 4Nm

3

ASSEMBLY
MONTAJE

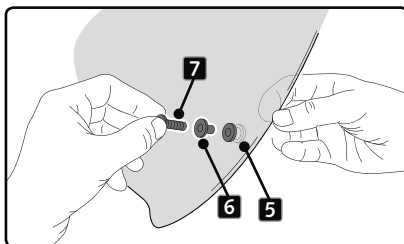
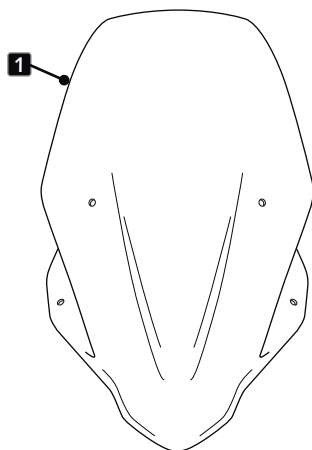

4

ASSEMBLY
MONTAJE

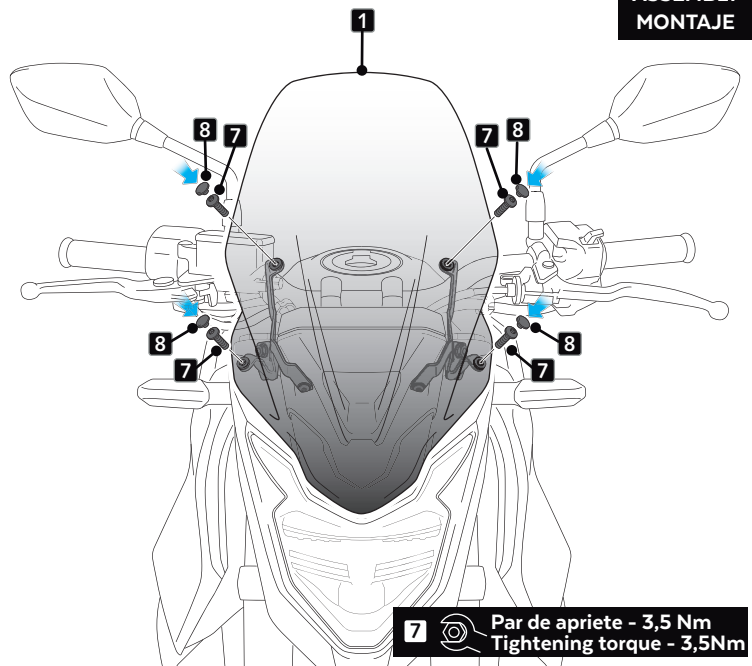

7 Par de apriete - 3,5 Nm
Tightening torque - 3,5Nm